

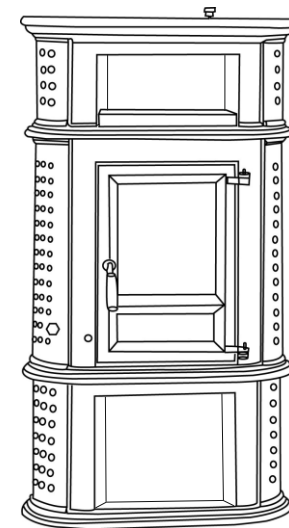

User's manual



Herculina XL



An der Bundesstraße 2 49733 Haren/Ems

Germany

Tel. +49(0)5932-7334784

[info@globe-fire.de](mailto:info@globe-fire.de)

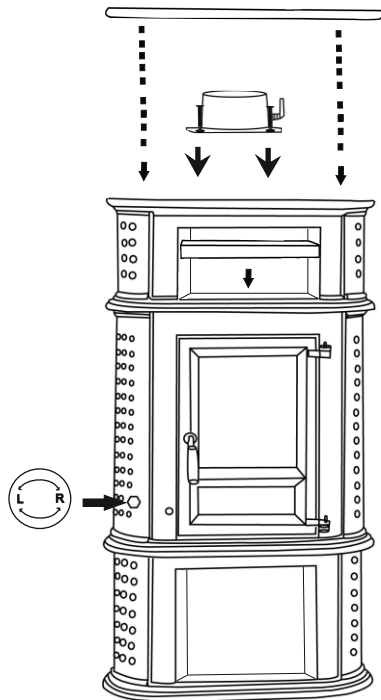

## **Congratulations with your new Globe Fire stove**

Cast iron stoves have a long tradition. Our business is in its 6th generation of development and production of stoves, insert fires and cookers.

Our models are all made of a high quality cast iron using advanced technology enabling you to burn your fire for long periods.

Please read the User's manual carefully and follow all instructions given.

We wish you a cosy warmth and much pleasure with our product in the years to come.

Your **Globe-fire** team.

## Safety regulations

The user must consult the user's manual for instructions on operating and using the stove

The stove has been tested according to German regulations and has acquired the Bauart 1 test.

This offers the possibility of connecting more than one burner to a single chimney.

The chimney sweeper should be consulted about this.

When the stove is in use the door must be closed.

The fire can be regulated by the revolving grid and the primary / secondary air regulator.

Do not close the primary / secondary air regulator before the wood has burnt to a glow and the flames are no longer visible.

In houses where air supply (necessary for the fire to burn) is taken from the room, there should be a sufficient supply of fresh air.

The ash door should always remain closed when the fire is burning. If the door is left open an uncontrollable amount of air is added to the fire which may prove dangerous as the stove can become overheated.

Parts that are in contact with the fire could buckle or even break.

When the stove is not used for a longer period of time, close the revolving grid and the primary / secondary regulator.

This is to ensure that any ash or smell of burning does not enter the house.

### **WARNING: CHILDREN PLAYING !!!**

**A stove becomes very hot when it is burning hot !!!**

## **Installation and operation manual for Stove model ST-670 XL Tested according to German standards: DIN EN 13240, Ö-Standard 15A and 1.+2. BimschV., CE and Luftreinhalte-Verordnung Switzerland**

### **1. INSTALLATION OF STOVE.**

The stove is ready for use and can be connected to the chimney with the flue pipe. If possible, connect the flue pipe, keeping it short, straight or slightly at an angle to the chimney.

Seal the connection (heat resisting fire rope).

When fitting the legs do not drag or push the stove but lift it (the legs could break off).

Connect the external air flow by using a pipe.

National or European standards, including local standards and any fire regulations must be complied with.

Ensure that there is sufficient air flow before burning wood.

This is particularly important in well insulated houses and those with a mechanical ventilation system.

To ensure your chimney has the correct measurements it is possible to measure it. Ask your chimney sweeper for advice.

Before placing the stove into position check to see if the floor can take the weight. When in doubt place the stove on a large slab of stone or marble to divide the weight.

### **2. GENERAL FIRE SAFETY INSTRUCTIONS.**

During wood burning, high temperatures are reached make it impossible to touch the top, sides or door without using heat resisting gloves.

Children must be made aware of the dangers and kept away for the stove when lit.

### 3. TYPES OF FUEL PERMITTED.

Use blocks of wood approx. 30 cm in length and 10 cm in diameter.  
Certain types of coal can also be used, with the exception of black coal and anthracite which is not recommended because of overheating causing the cast iron to warp or break.

Wood must be dry. (max. 20% moisture content)  
Burning synthetic materials, plastic, varnished wood or other materials is strictly forbidden by law because of emission of harmful gasses endangering health.  
The chimney and stove will become severely damaged and the smell produced is a hindrance for the neighbourhood.

Unlike gas or oil, wood cannot burn overnight.

### 4. OPERATION OF THE STOVE.

Lighting the stove for the first time will cause an unpleasant smell and blue damp. Leaving a window open while the paint is hardening is recommended.  
Make sure the fire burns well so that the paint hardening process is successful.  
Once this is done no more trouble with smell and damp will occur.  
Never use methylated spirits, petrol or other fluids to light the stove, this can be very dangerous.  
Using a firelighter is recommended.  
The wood used must not be younger than 2 years and no older than 6 years.  
Young wood is too wet and will produce too much soot. Old wood is not suitable to start a fire as it no longer contains any gasses, which will prevent the right temperature being reached quickly for a fast and clean burning.

With the technique we use, the fire will burn at its best within 15 to 20 min.  
Before starting the fire, check to see that all air vents are open.  
When the fire is burning well the fire grid can be closed and the flames regulated with the primary / secondary regulator.  
Do not close up completely while flames are visible. (This is to avoid smoke entering the room)  
Stay with the stove until burning well.  
If the fire has been started well the stove should remain quite clean.  
Wait until the wood has burnt to a glow before putting on more logs

### 5. GLOBE FIRE RECOMMENDATIONS “ LIGHTING THE FIRE “ ON PAGE 12.

### 6. AIR SUPPLY.

Always make sure there is enough air in the room.

### 7. USING THE FIRE IN THE AUTUMN AND SPRING.

In these seasons of the year when the outside temperature is higher your chimney may not have a good chimney draught and the smoke will not be sucked out enough. In this case it is recommended to use a lot of dry wood (three quarters full) not older than 6 years.  
By lighting the fire for the first time, also when the temperature is not so high, follow the Globe fire recommendations “ lighting the fire “!

### 8. CARE AND MAINTENANCE.

The stove must be cleaned yearly and occasionally even more often.  
It is recommended that the chimney is swept every year by a professional chimney sweeper.  
The **Globe-fire** stoves have been treated with a heat resisting paint. After this has hardened, the stove can be cleaned with a damp cloth, using a dry cloth to dry off afterwards.  
The stove window can be cleaned with a glass cleaner.  
Badly stained glass can be cleaned with a special gel or oven cleaner.  
Never clean the stove when it is hot.  
Remove the ash between the fire grid so that the grid will revolve easily.

## 9. STOVE WITH SELF CLOSING DOOR.

As our stoves have self-closing doors (fitted with a resisting spring) it is possible to have more stoves connected to the same chimney.  
All stoves must be fitted with a self-closing door.  
To make sure this connection is possible please contact a chimney sweeper.  
The fire must not be lit with an open door.  
If the other stoves do not have a self-closing door or they are open fires it is not possible to connect more stoves to one chimney.  
In this case the chimney draught is not correct and the room could fill with smoke.

## 10. FRESH AIR FLOW FOR MAXIMUM COMBUSTION.

If your house is fitted with a mechanical ventilation system it is necessary to use an external air flow which can be fitted on to the rear of the stove.  
Problems can also occur if an extractor hood with a high extraction capacity is fitted in your kitchen and the house is well insulated.  
Too much air will be taken out of the room causing smoke to be extracted from the stove.  
This can be solved by placing an automatic switch in your extractor hood which only works with a window open.  
These can be supplied by your electrician.

## 11. ACTION TO BE TAKEN BY A CHIMNEY FIRE.

Using wet wood, burning at low temperatures or using the wrong sorts of fuel can cause a depository of soot in the chimney.  
This can result in a chimney fire.  
In this case close all air vents and contact the fire brigade.  
After the fire, get your chimney sweeper to check for any cracks that may have occurred and sweep the chimney.

## 12. FIRE SAFETY DISTANCES.

### Furniture and flammable wall.

The distance from the back of the stove is 20 cm.  
From both sides 20 cm.  
From the glass 80 - 100 cm.

### Floor.

A flammable floor ( carpet, wood etc. ) must be protected by a fireproof plate that is 30 cm wider on both sides and at least 50 cm in front.  
Each type of stove may have different regulations.  
The distances required for your stove are found by consulting the page on types of stoves in your user's manual.

## 13. PARTS.

It is only possible to replace parts with original parts belonging to the stove.  
These parts can be ordered through your supplier.  
The fireplace must under no circumstances be altered in any way.

## 14. CAPACITY.

This stove has been tested at 7 kW.  
When adding fuel it is recommended not to use more than 3 blocks of wood.  
When using brown coal use only 3 or 4 briquettes.

**Do not open the stove door before the wood has burnt to a glow and flames are no longer visible !!!**

## 15. CAPACITY.

Capacity, depending on the building material used for your house and tested according to European and German requirements:

Favourable conditions	- 120 - 150 m <sup>3</sup>
Average conditions	- 120 m <sup>3</sup>
Unfavourable conditions	- 82 m <sup>3</sup>

## Durability

As a family business in our 6th generation durability has become one of our core values.

The materials we use for our products are of a high quality and completely recyclable which makes it possible to re-use after a long period of time.

In order to lengthen the lifespan of our stoves it is important for you to take care of your stove and when necessary replace parts. These parts can be ordered through us or our dealers.

We produce stoves using the latest technology which we have developed ourselves. All the required regulations and emission level standards were reached with ease.

It is essential to keep the stove burning in the correct manner and use the prescribed fuel.

This not only prolongs the lifespan of the stove but also ensures a clean burning with the minimum of environmental taxation.

In this way unnecessary wastage and unnecessary taxation is avoided.

### GUARANTEE

30 months guarantee.

This guarantee is only valid under normal use of the fire and for the operation of the stove. It does not cover overheating, scratches, parts that normally wear out or any part in direct contact with the fire. (glass, fire grid, sealing, etc.)

The guarantee does not cover insufficient servicing of the stove or use of any parts other than parts from **Globe-fire**. Before operating the fire, the user is expected to read the user's manual and the guarantee.

After use the stove cannot be returned.

After repairs the guarantee expires and cannot be renewed.

FAULTS	CAUSES	SOLUTIONS
The stove develops smoke on the top plate and smells.	1 This only occurs when the paint is hardening. (lighting for the first time)	1 Let fire burn well and make sure of fresh air. Open all doors and windows.
The stove has not enough chimney draught when lighting the fire. Fire will not burn.	2 Air vent is closed. 3 Chimney vent is closed. 4 Wood is too wet. 5 Wood is too old. 6 Not enough wood. 7 Wood is too small. 8 External air pipe is too close to the wall. 9 Unfavourable weather. (heavy mist) 10 No chimney draught. 11 Chimney is dirty or has an air lock.	2 Open air vent. 3 Open air vent. 4 } Only use seasoned wood 5 } between 2 and 6 years old. 6 } See page 12. 7 } 8 Move stove forwards. 9 Occurs seldom. See point 10 / 11. 10 } Ask chimney sweeper. 11 }
When adding wood smoke enters the room.	12 Refilled too soon. 13 Air supply closed too soon 14 Stove pipe full of soot or ash. 15 No chimney draught.	12 Only refill when fire has burnt to a glow. 13 Open air vent. 14 Clean stove pipe. 15 Phone chimney sweeper.
Soot forms constantly on stove glass.	16 Fire not hot enough when building up fire. 17 Air supply closed off too soon. 18 Wood too old or wet.	16 See page 12. 17 Open air vent. 18 Only use seasoned wood between 2 and 6 years old.
Room smells of burnt wood and cooled ash.	19 Added new wood too soon.	19 Only add more wood after first wood has burnt to a glow.

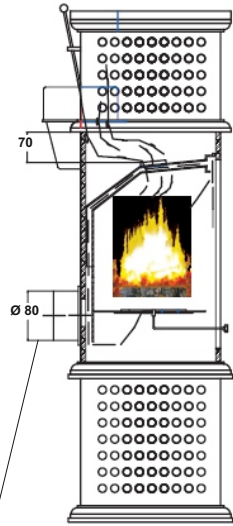
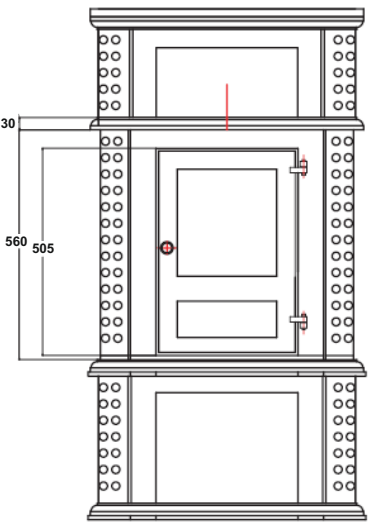

External air flow

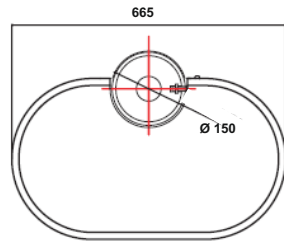
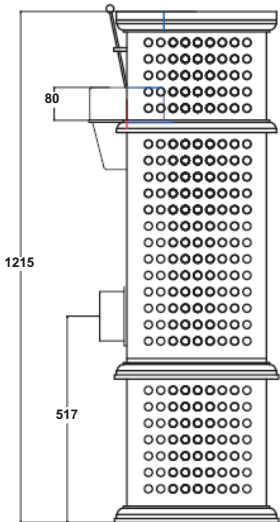

## PARTS

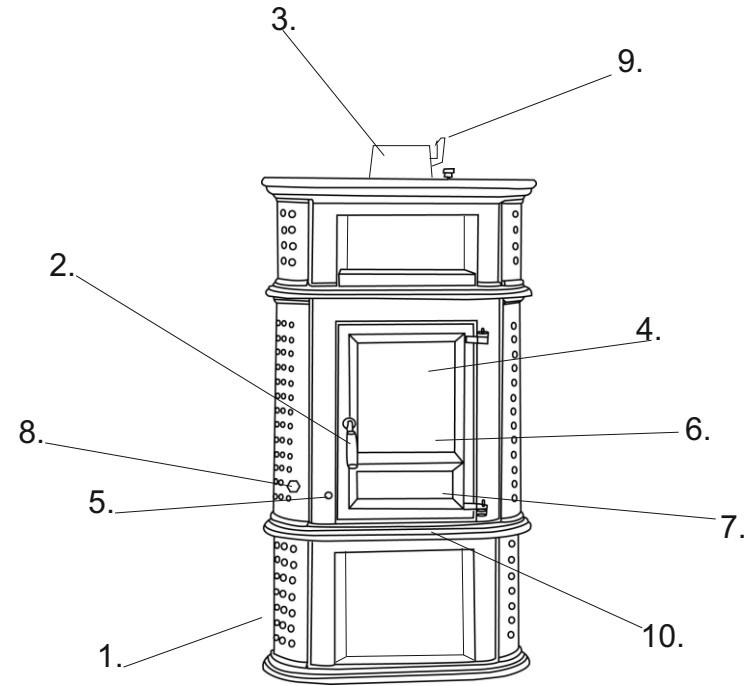

Herculina XL

- |                         |                                  |
|-------------------------|----------------------------------|
| 1. Stove base           | 7. Ash tray                      |
| 2. Door handle          | 8. Primary / Secondary regulator |
| 3. Flue connection      | 9. Air vent pipe                 |
| 4. Stove window         | 10. External air flow (rear)     |
| 5. Fire / rotation grid |                                  |
| 6. Cinder guard         |                                  |

# Globe Fire recommendations

## Lighting the fire:

Open the primary / secondary air vent.  
Check to see if an eventual air vent or pipe in your burner is open.

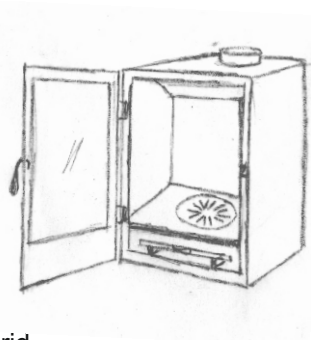

1. Open the fire / grid.



2. Place two large logs (10 cm thick) on the fire grid completely covering the grid.  
Use a round log or chopped wood.



3. Place a firelighter in the middle.

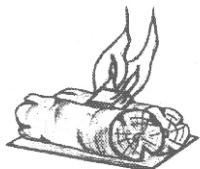

4. Light the firelighter.



5. When the firelighter starts to burn place two large logs (10 cm) in the flames.  
Close the door.

When the stove is hot (approx. 15 - 30 minutes) close the grid.

Add further wood using 1, 2, or 3 logs. Make sure the wood has a real glow of flames before doing this. (to prevent smoke in the room)

## - Globe fire -

Globefire Ch.Leibfried GmbH, An der Bundesstraße 2,  
D-49733 Haren / Ems, Germany

**Tested stove Type 1: EN 13240: 2001+A2: 2007**

Type	Stove Herculina ST 670		
Declaration of performance Nr.	007-CPR-2013.06.10		
Test institute Number	1625		
Test-Nr.	RRF - 40071506		
Heat output / Energy efficiency	Fulfilled		
.Efficiency	80,3 %		
.Nominal heat output	7 kW		
.Room efficiency	7 kW		
.Heat output	6 - 8 kW		
Mechanic solidity	Fulfilled		
Surface temperature	Fulfilled		
Combustion products	CO-Emission: 1250 mg/Nm <sup>3</sup> - 753 mg/MJ		
.Flue gas temperature	245 °C		
Fire safety	Fulfilled		
.Fire behavior	A1		
.Minimal distance to flammable materials:	Side: 20 cm	Rear: 20 cm	Bottom: 0 cm
	Front stove window: 80 cm		
Fuel	Wood and coal	Time burning	
Dust in Mg on 13% O <sub>2</sub> : 37 mg/Nm <sup>3</sup>	Nox: 128 mg/Nm <sup>3</sup>	CO: 1250 mg/Nm <sup>3</sup>	OGC: 75 mg/Nm <sup>3</sup>
Values (converted): 24 mg/MJ	81 mg/MJ	753 mg/MJ	48 mg/MJ
VKF Switzerland	25293		

Reading and follow up of given guidelines in the manuel

The connection of more stoves to one chimney is permitted



Approved German tests and CE mark EN 13240:2001 + A2:2007, according DINplus and also according Art. 15A B-VG Ö-Norm Austria.  
1. and 2. level 1. BimschV Germany and also Luftreinhalte-Verordnung Switzerland.